8.1	32
8.2	32
8.3	32
9.	33
9.1	33
9.2	34
9.3	35

1. 前言

本说明是尽我们全部努力编制而成的客户资料。总结了 we 实践经验的结果。
如果不遵守说明中的指示，我方将不承担任何责任！



1.1 所属资料

下列资料属于本说明书：

1. 接受订单或发货单——提供有关阀门运行条件的信息
2. 阀门的图纸——
提供有关阀门装备的信息，以及重量和有关安装、调试、运行和维护的进一步提示
3. 附录 1——
提供有关阀门（包括驱动装置和其它配件）装备的信息，以及配件的重要电气和气动数据（如有涉及）
4. 补充的操作说明书，或资料——
为一同交付的配件的调试、运行和维护工作提供进一步提示。
5. 附录 2 和 3——
如果计划在爆炸危险的环境中按照规定使用闸阀，或将其作为压力容器使用，则只随操作说明书提供附录 2 和 3。

这些资料包含安装、调试、运行和维护时务必遵守的附加提示。

1.2 提示的含义

	<p>警告</p> <p>意思是：如果没有遵守相应的安全措施，可能发生死亡、重伤或轻伤、或严重的财产损失。</p>
	<p>小心</p> <p>意思是：如果没有遵守相应的安全措施，可能出现财产损失。</p>
	<p>提示</p> <p>是有关产品、其搬运的重要信息，或尤其需要遵守或包含进一步信息的文件部分。</p>

1.3 标记

闸阀在驱动装置范围内安装有下列 ENA 工厂标牌。如果闸阀是符合 ATEX 产品章程 94/9/EG 或压力设备章程 97/23/EG 的设备，则进行相应标记。标记不允许去除或损坏。

 www.ena-gmbh.de
识别号
制造年份:

2. 引言

该阀门以完好无缺的状态出厂。

为了保持这种状态，确保安全运行，请务必遵守本操作说明书中提到的提示和注释。

**警告**

阀门只允许由具有资质的人员安装、运行和维护。

-
-
-
-
-

ATEX 产品章程 94/9/EG

在阀门上加装装置，或阀门自身用于符合章程 1999/92/EG 的爆炸危险区域内，例如操作安全规程。

ENA GmbH
Spielburgweg 23
D-41844 Wegberg

+49 (0)2434 997040

+49 (0)2434 997041

电子邮件：

info@ena-gmbh.de info@ena-gmbh.de

网址：

www.ena-gmbh.de

3.

ENA

ENA

2

1.1

3.1

1.1

0.5bar

2

1.1

3.2



4.

-
-

-
-
-



4.1

<ul style="list-style-type: none"> • • • • <p>500 kg</p>	<ul style="list-style-type: none"> • • • • <p>的配</p>

1



5.

- 1.1
-
-

5.1









ENA

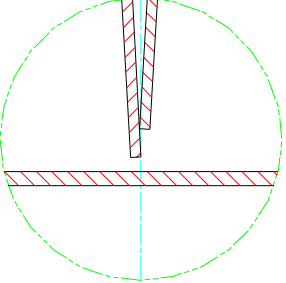

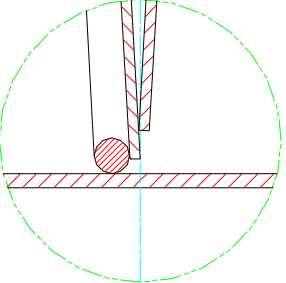
PG

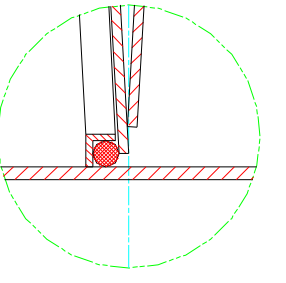
5.1

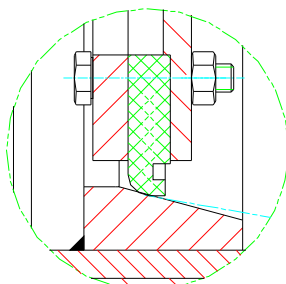
	<p>D</p>		
	<p>M</p>		
	<p>W</p>		
	<p>EX</p>		



5.2

-
-
-
-



5.2.1

5.2.2



5.3

100°C以上的闸阀应该绝缘，避免放射的热量传递到加装的配件上。

配件

(X)

70mm

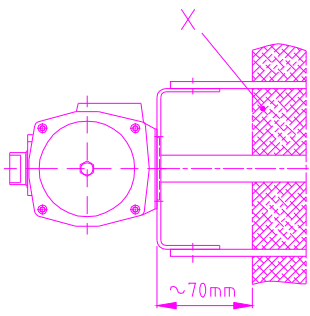
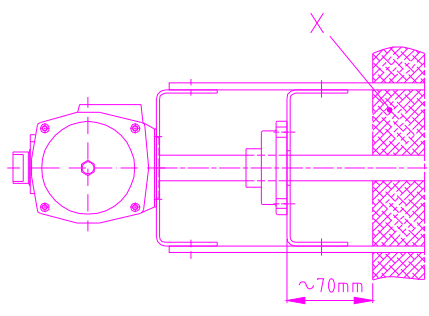
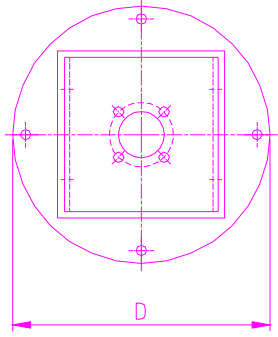
	
<p>m</p> <p>200m</p> <p>6.2.1</p>	 <p>1</p>

3

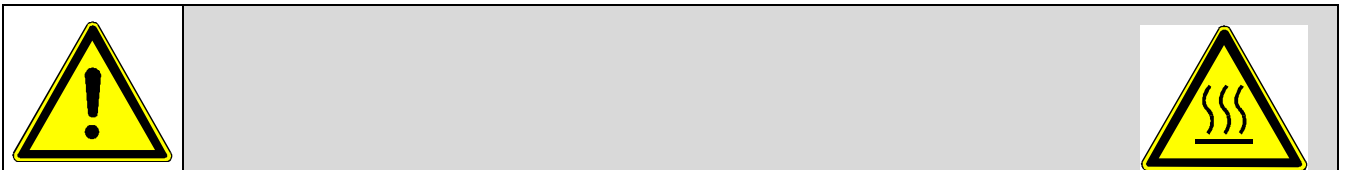

5.3.1

50°C。

>50°C

(PSA)

5.4

1.1

VDE

6.

6.1

-
-
-
-

9.1

6.1.1 “ ”

“ ”

90°

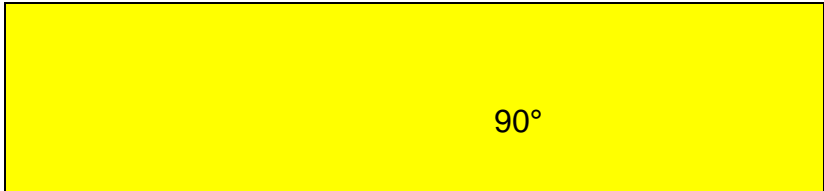

6.2

-
-
-

6.2.1 具有法兰连接并在法兰中夹紧的阀门

6.2.2



6.3

7.

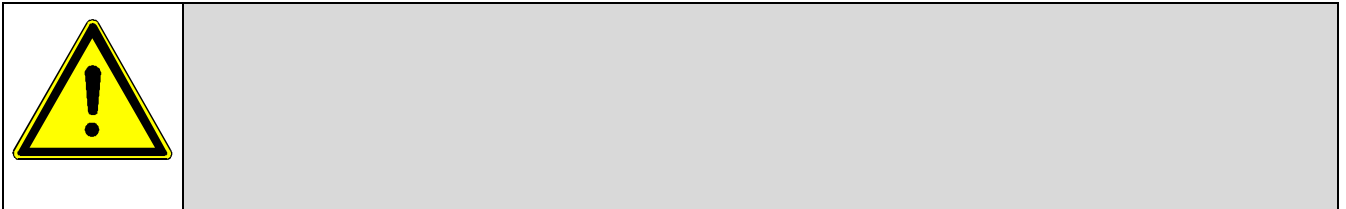

9.2

7.1

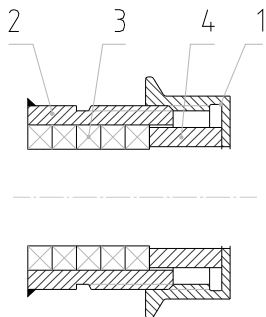

1		
2		
3		V
4		

2 SDK

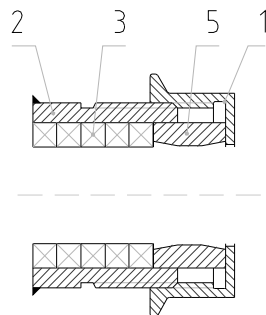

1		
2		
3		V
5		V

3 SGK

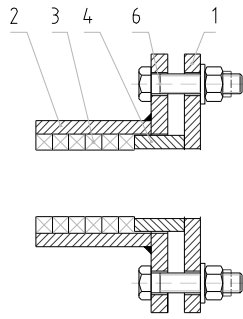

4 SDB

1		
2		
3		V
4		
6		

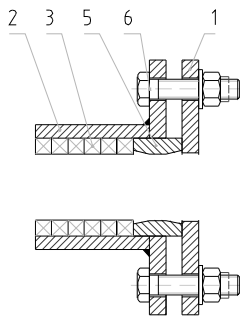

5 SGB

1		
2		
3		V
5		V
6		

4

7.1.1

A

B

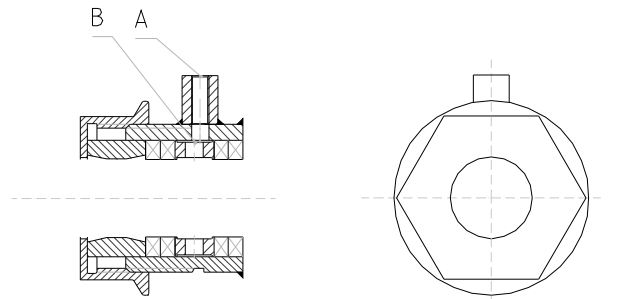

6 SDKS & SGKS

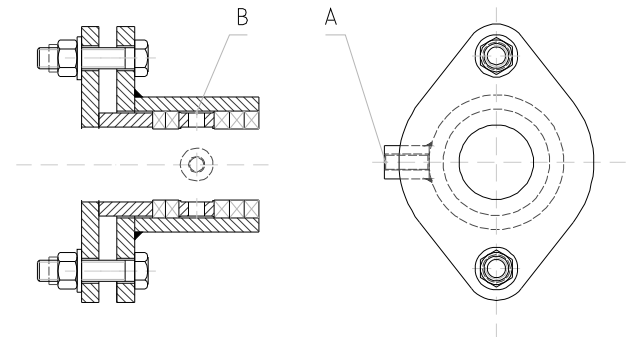

7 SBDS & SBGS

轴-Ø	16	22	32	40	50	60	70	80	90	100
	DIN	G 1/8"	G 1/4"							
2986			0.10 0.5 m³/h							
			+ 10 mbar							

5

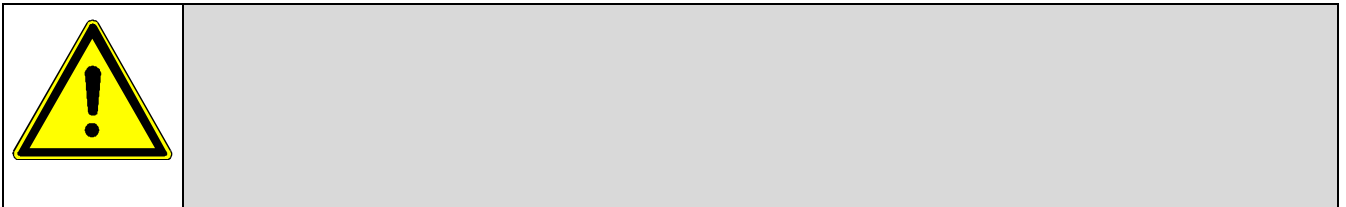

7.1.1.1

9.3

10 14

SKG – SKD

SBG – SBD



7.1.1.1.1

-
-
-
-
-
-
-
-
-
-

在使用按米销售的填料时，将45° 以下的填料根据轴直径(d)和填料截面积(s) 剪切为长度 (L)¹， $L=(d+s) \times p + s$ 。

90°。

9.3

10 14



图 1:

7.1.1.1.2

20 N/mm²。

¹ ENA

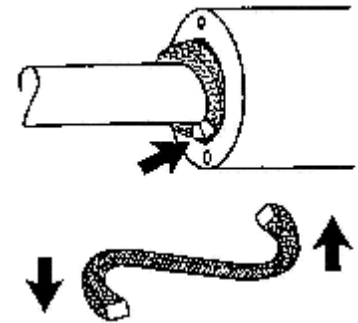
7.2



7.2.1

H1

FP

7.2.2

2000

	-50	0	+50	+100	+150	+200	+250		NIGL								
UCF & UCFL	-30				+120				A	2	OKS 402						
PCJ & PCJT	-30				+150				B	2	OKS 404	Isoflex Topas L152					
RCJ...FA125	-20						+250		C	2	OKS 4220	Barrierta L55/2					
	A			B				C PTFE/聚全氟醚油									
-Ø	15	20	25	30	35	40	45	50	55	60	65	70	75	80	90	100	



[g]	2.0	2.5	3.0	4.5	5.5	7	7.5	8	10	10.5	14	14	14.5	15.5	20.5	26
-----	-----	-----	-----	-----	-----	---	-----	---	----	------	----	----	------	------	------	----

7.2.3

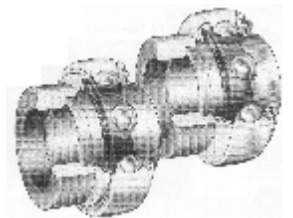
FP

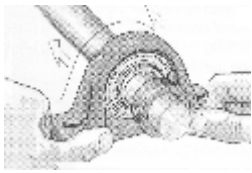
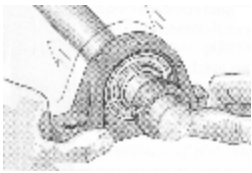
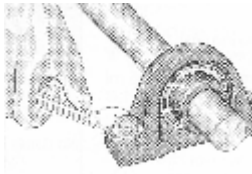
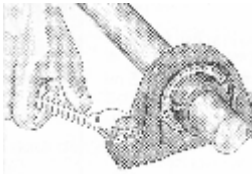

7.2.4

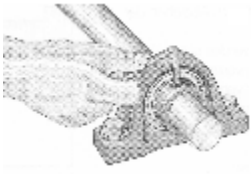
			
M _A)		M _A	
		8	M _G 

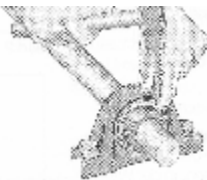
		OKS90	
			

7.3.

—

7.3.1

7.3.1.1

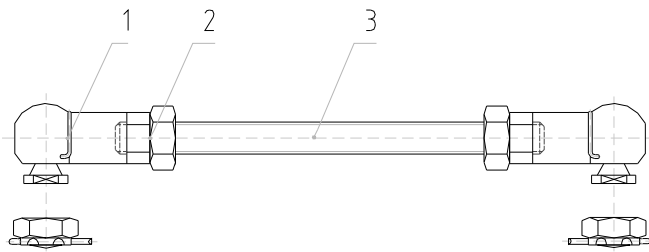

1	
2	
3	

9 耦合杆 AS13-K & AS19-K

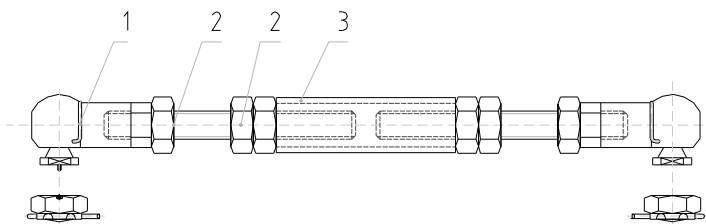

1	
2	
3	

10 耦合杆 AS19-L

	AH32-1 35x25	$\pm 27 \text{ mm}$	M 30
--	--------------	---------------------	------

7

	(3)	(1)	3
---	-----	-----	---

7.3.2

7.3.2.1

$\pm 8^\circ$

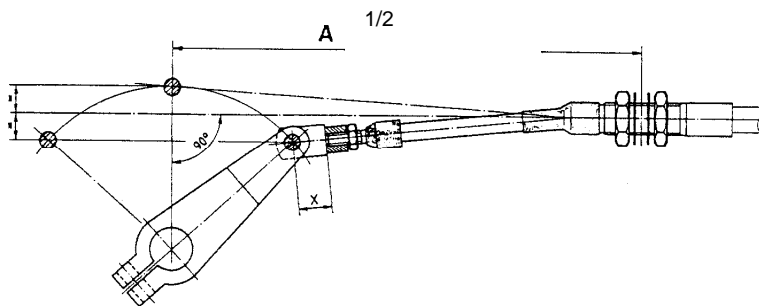

12

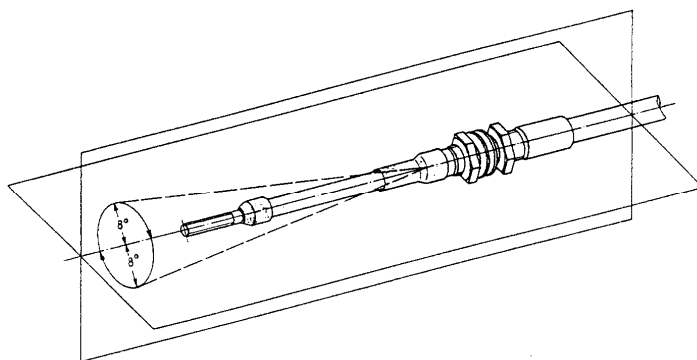

13

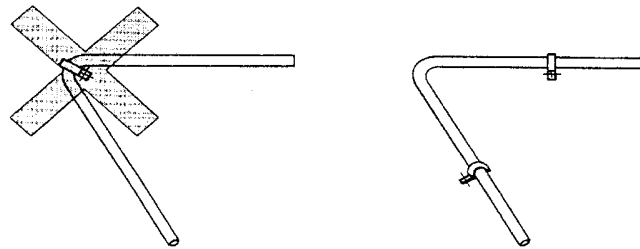

14



7.3.2.2

-
-
-
-
-
-
-



作为材料。

聚醛树脂和PTFE

7.4

1.1

7.4.1

-
-
-
-

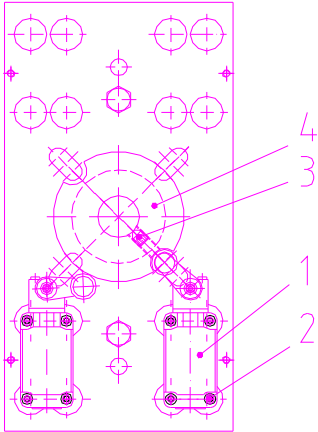
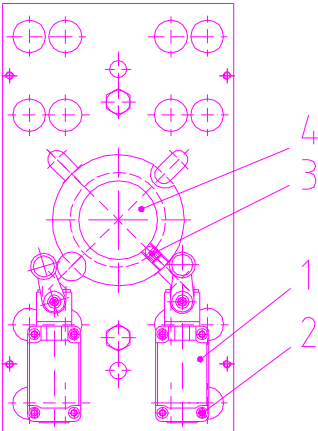
<p>15</p> 	<table border="1"> <thead> <tr> <th colspan="2">名称</th> </tr> </thead> <tbody> <tr> <td>1</td> <td></td> </tr> <tr> <td>2</td> <td>&</td> </tr> <tr> <td>3</td> <td></td> </tr> <tr> <td>4</td> <td></td> </tr> </tbody> </table>	名称		1		2	&	3		4	
名称											
1											
2	&										
3											
4											
<p>16</p> 	<table border="1"> <thead> <tr> <th colspan="2">名称</th> </tr> </thead> <tbody> <tr> <td>1</td> <td></td> </tr> <tr> <td>2</td> <td>&</td> </tr> <tr> <td>3</td> <td></td> </tr> <tr> <td>4</td> <td></td> </tr> </tbody> </table>	名称		1		2	&	3		4	
名称											
1											
2	&										
3											
4											

7.4.2

500

7.4.3

	<p>(3) OKS 90 (www.oks-germany.de) 保护!</p>
---	--

7.4.3.1

-
- (3)
- (3) M_G (第 9.3 节表 8: 螺纹销的拧紧扭矩)
-
- (3)
-
- § (2)
- § (1)
- § (2)

7.4.3.2

-
- (3)
- (3) M_G 9.3 8
-

-
-

§ 松开 (2)

§ (1)

§ (2)

	<p style="text-align: right;">1.1</p>
	

7.5

1.1

	
---	--

在闭合开口时检查密封件，必要时更换。²

7.6

1.1

²

7.6.1

1.1

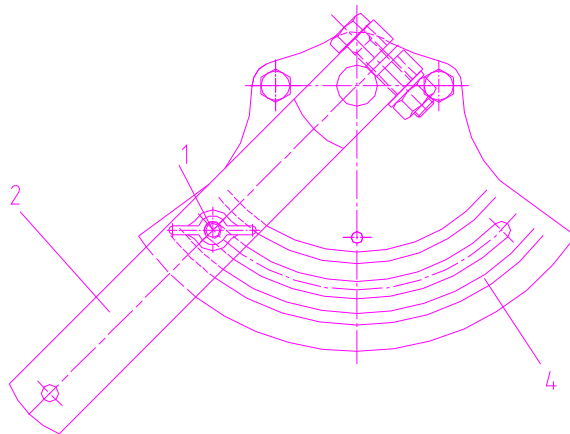

HH63-250

(1) (2)

(1)

(4)

17 手杆 HH63-250

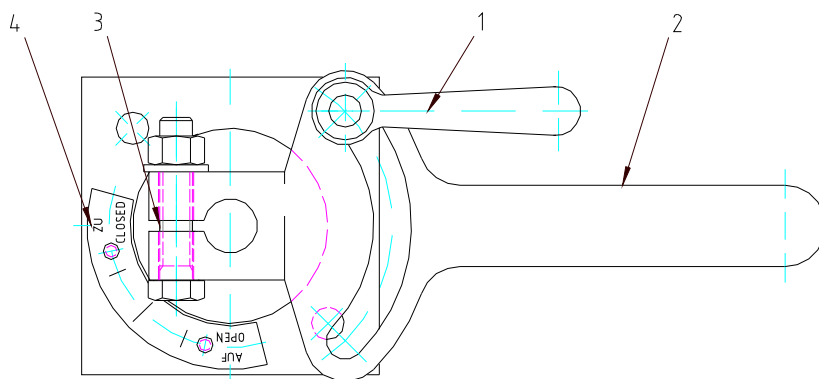

手杆HH280-500 或 HH560-1000
可无级调节。 (1)

(2)

(3)

(4)

18 手杆 HH280-500 / HH 560-1000

	<p>(1)</p>
--	------------

7.6.2

-
-

-
-

1.1

	1.1
---	-----

7.6.3 –

	ZU AUF AUF
---	------------------

-
-
-
-
-
-

DIN 127

9.3 14

1.1

1.1

	
---	--

7.6.4 –



ZU

-
-
-
-
-
-

9.3 11

7.3

1.1

1.1



7.6.5



7.6.6

1000

1000



1.1

7.7



8. EN ISO 12100-1/2

EN ISO 12100-1 -2

ENA有限公司。

2

8.1

EN 294 EN 563

8.2

1000
一个人孔。

0.8m²以上的闸阀，应该为内部检修在管道或通道上开

8.3

—

—

9.

9.1

	X		5.2
		X	6.2.1
		X	6.2.2
		X	7.1.1.1
		X	7.2.2
		X	7.2.2
		X	7.3.1.2.1
		X	7.3.1.2.1
		X	7.3.2.1
	X		7.4.3
	X		7.4.3.1
		X	7.5
	X	X	7.6.1
	X	X	7.6.3 7.6.4
	X	X	7.6.5

“ ”	X			6.1.1
	X	X		5.4
	X	X		6.1

9.2

			5 0 0	1 0 0 0	2 0 0 0	
	X					6.1
					X	7.1.1.1
					X	7.1.1.1
					X	7.2.2
					X	7.2.2
					X	7.2.2
			X			7.3.1.2
			X			7.3.2
限位			X			7.4.2
			X			7.4.3
			X			7.4.2
				X		7.5
	X					7.6
			X			7.6.3 和 7.6.4

				X			
				X			7.6.6
				X			7.6.6

9.3

	M_G
2,5	3.6 Nm
3	6 Nm
4	14 Nm

8

	M_G
5	26 Nm
6	42 Nm

	M_A
M6	10 Nm
M8	25 Nm
M10	41 Nm
M12	72 Nm

9

	M_A
M14	115 Nm
M16	180 Nm
M18	245 Nm
M20	345 Nm

8.8

	M_A
M8x1	27 Nm
M10x1.25	52 Nm
M12x1.25	95 Nm
M12x1.5	90 Nm

10

	M_A
M14x1.5	150 Nm
M16x1.5	225 Nm
M18x1.5	325 Nm

8.8

	M_A
M6	3.5 Nm

	M_A
M16	135 Nm

M8	16 Nm
M10	32 Nm
M12	56 Nm

11

A2/A4

M20	280 Nm
M24	455 Nm
M30	1050 Nm

70

	M _A
M6	10 Nm
M8	25 Nm
M10	50 Nm
M12	86 Nm

12

	M _A
M16	220 Nm
M20	420 Nm
M30	1500 Nm
M36	2500 Nm